

15

## Intestine, Rectum

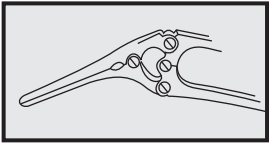



Intestinal Clamp Forceps

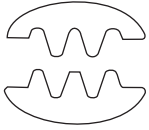

Atrauma

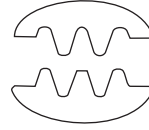

Atrauma

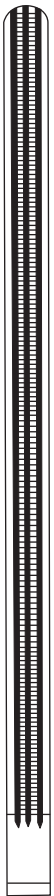

DC15-001-25  
25cm/10"



DC15-003-25  
25cm/10"



DC15-003-21  
25cm/8 1/4"

DC15-003-23  
23cm/9"

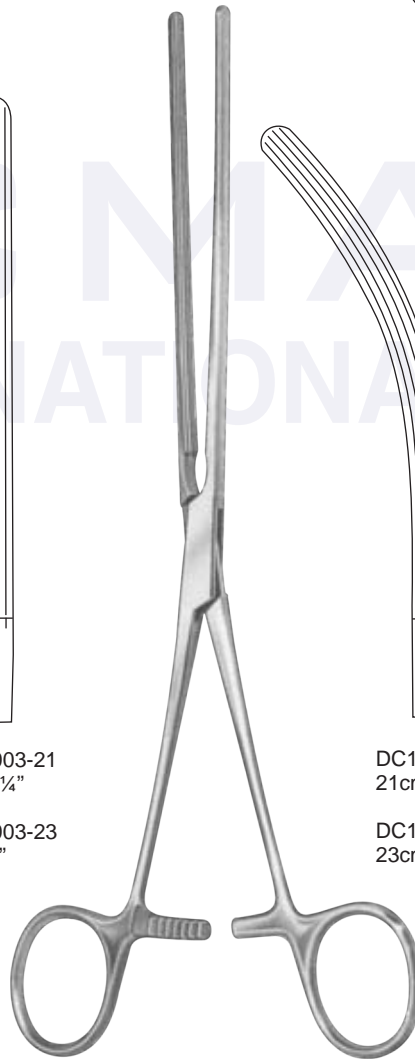

**Mayo-Robson**  
very flexible



DC15-005-21  
21cm/8 1/4"

DC15-005-23  
23cm/9"

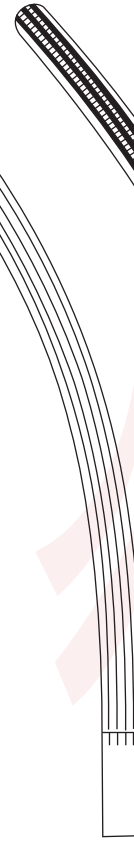

DC15-005-25  
25cm/10"

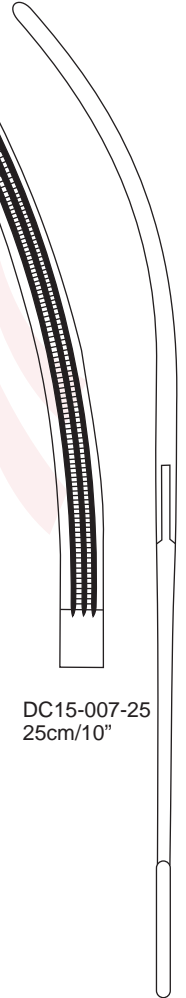

DC15-007-25  
25cm/10"

Intestinal and Stomach Clamps (Crushing Clamps)

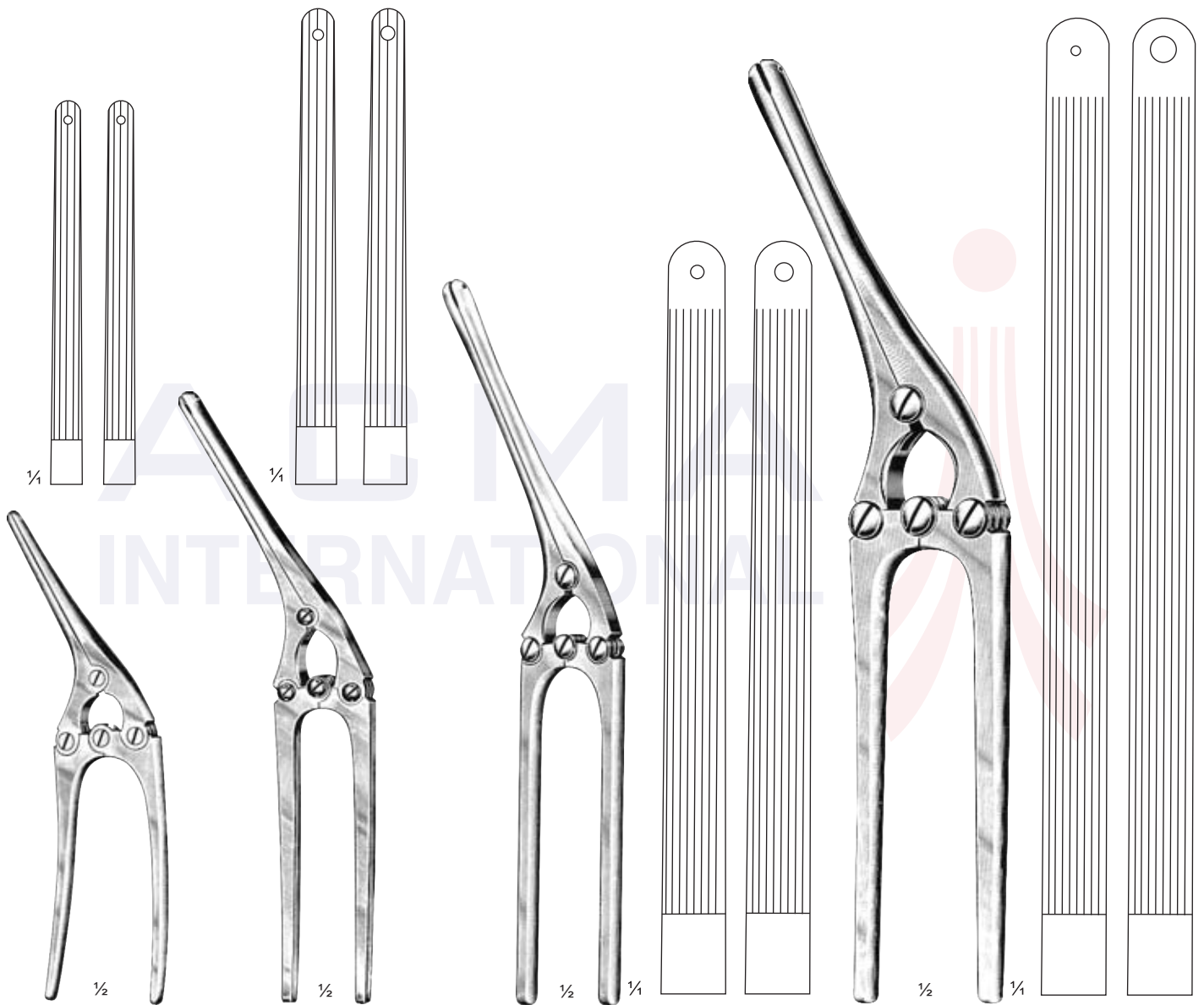
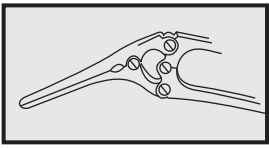

**Payr-Baby**  
15 cm / 6"

**Payr**  
21 cm / 8 1/4"

**Payr**  
29 cm / 11 1/2"

**Payr**  
35 cm / 13 3/4"

without pin

with pin

without pin

with pin

without pin

with pin

without pin

with pin

DC15-009-15  
Intestinal Crushing  
Clamps, for children

DC15-011-15  
Intestinal Crushing  
Clamps, for children

DC15-013-21  
Intestinal Crushing  
Clamps

DC15-015-21  
Intestinal Crushing  
Clamps

DC15-017-29  
Intestinal Crushing  
Clamps

DC15-019-29  
Intestinal Crushing  
Clamps

DC15-021-35  
Pylorus Clamps

DC15-023-35  
Pylorus Clamps

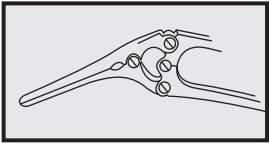

Intestinal Clamp Forceps

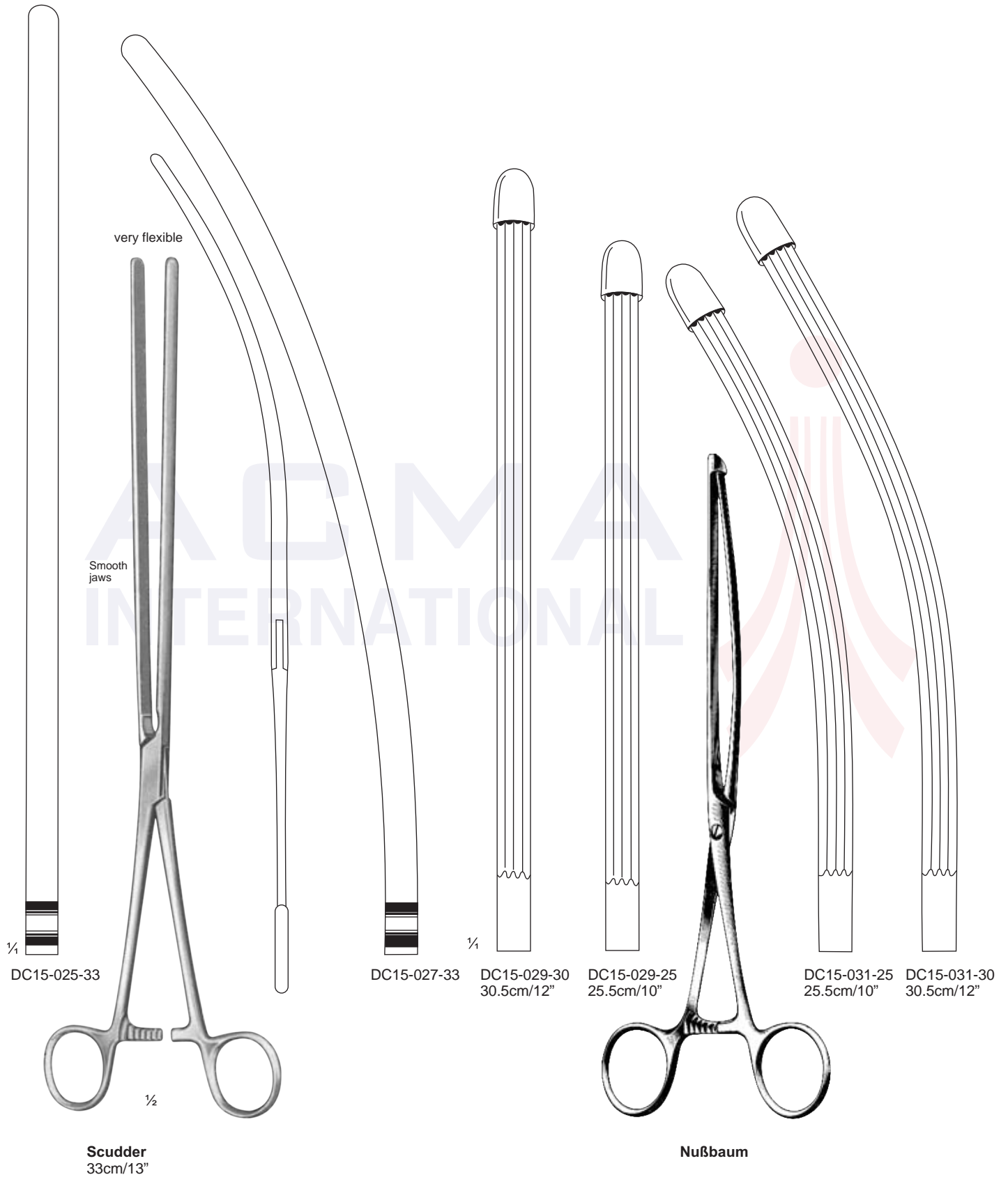

Intestinal Clamp Forceps, Pylorus Separator

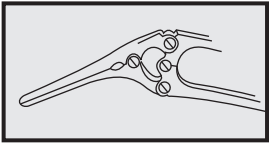

**Benson**  
DC15-033-15  
17cm/6"  
Pylorus Separator

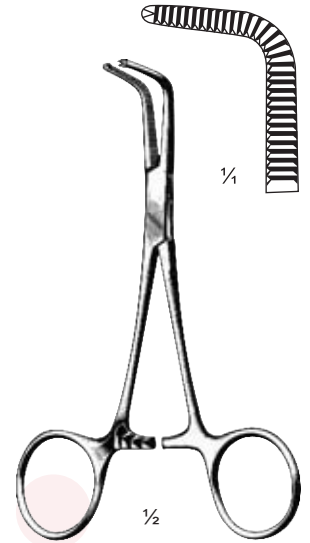

**Kleinschmidt**  
DC15-035-12  
12cm/4 3/4"  
Appendectomy Clamp  
and Suer Crusher

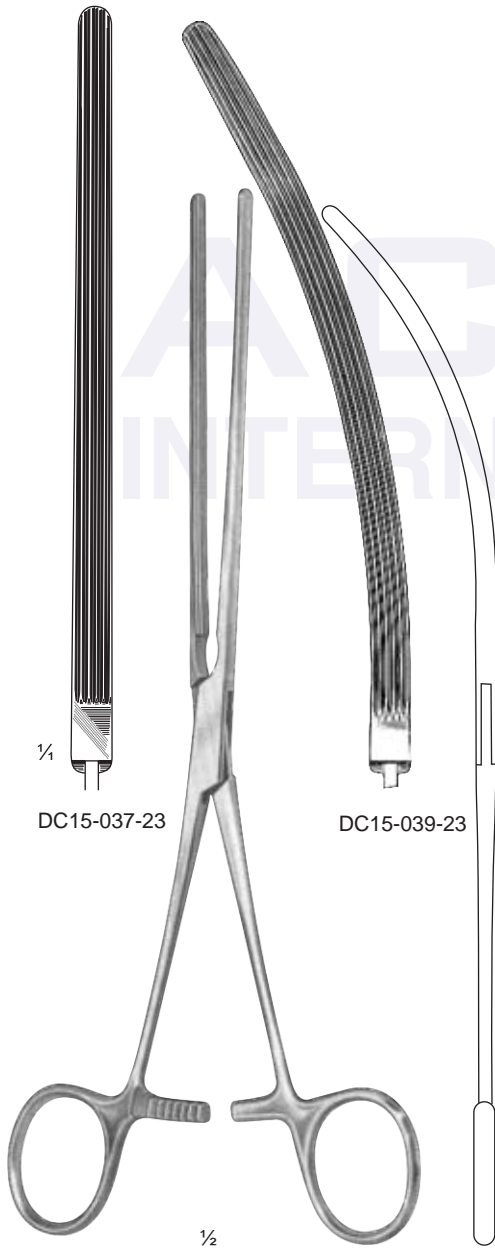

**Kocher**  
23cm/9"

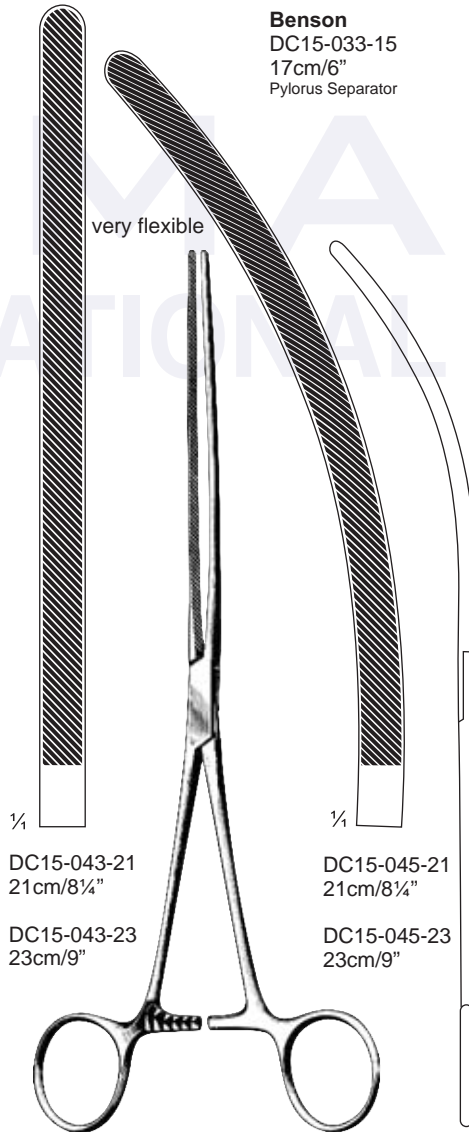

**Doyen**

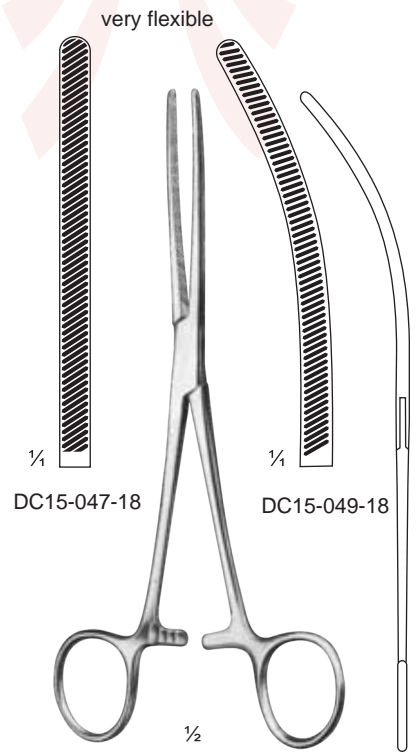

**Baby-Doyen**  
18cm/7"

Intestinal Clamp Forceps

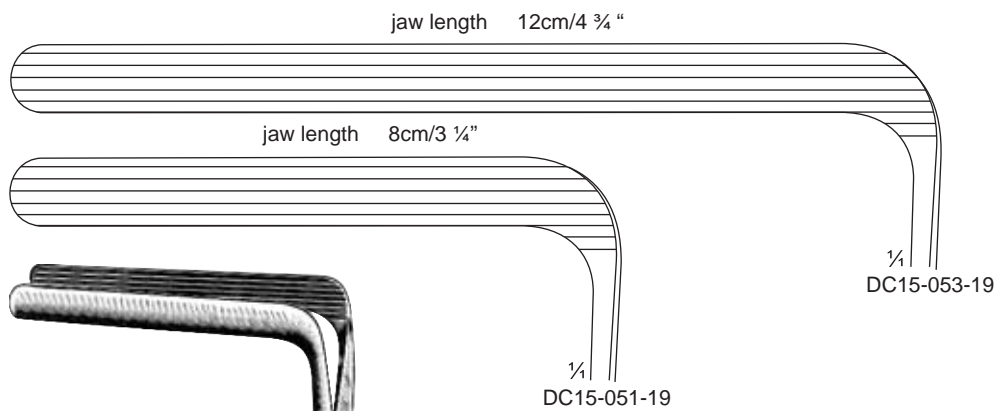
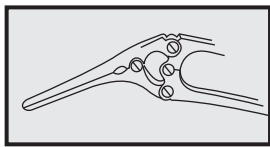

**Mikulicz**  
19 cm / 7 1/2"

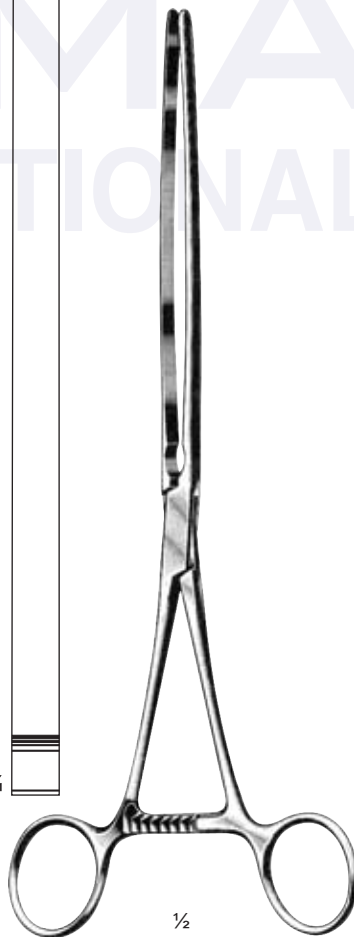

**Scudder**  
DC15-055-25  
25 cm / 10"

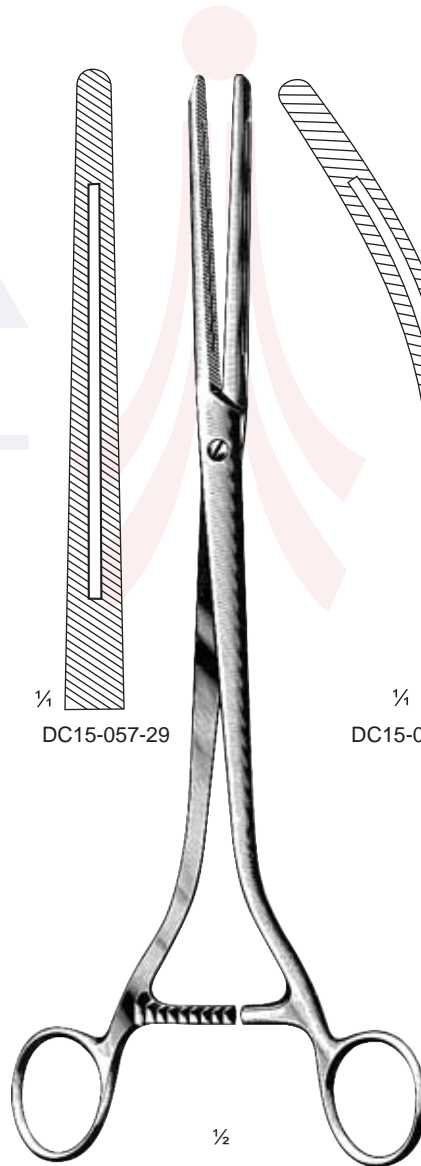
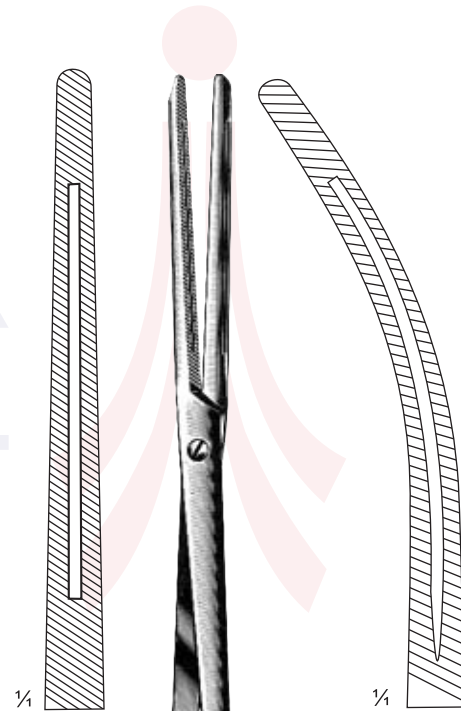

**Moynihan**  
DC15-059-29  
26 cm / 11 1/2"

Tissue Seizing Forceps, Intestinal Tissue Forceps

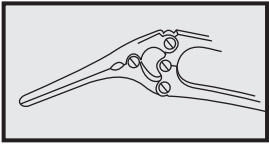

Allis		4:5	5:6
cm.	in.		
15	6"	DC15-061-15	DC15-063-15
19	7 1/2"		DC15-063-19
25	10"		DC15-063-25



**Boys-Allis**  
DC15-065-15  
15 cm / 6"

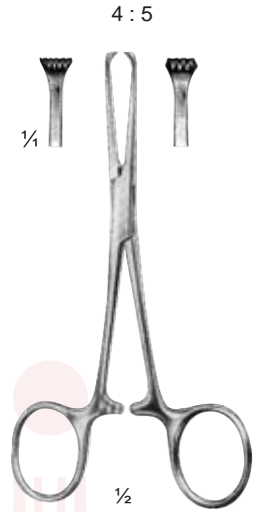

**Allis-Baby**  
DC15-067-12  
12 cm / 4 1/2"  
4:5 teeth



**Allis**  
DC15-069-20  
20 cm / 8"



**Judd-Allis**  
DC15-071-15 = 15 cm / 6"  
DC15-071-19 = 19 cm / 7 1/2"

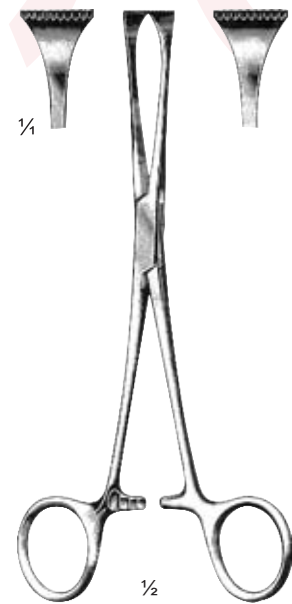

**Allis-Adair**  
DC15-073-15  
15.5 cm / 6"  
10:11 teeth

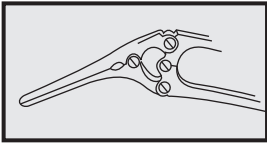

Tissue Seizing Forceps, Intestinal Tissue Forceps



**Lockwood-Allis**  
DC15-075-16 = 16 cm/6 1/4"  
DC15-075-20 = 20 cm/8"

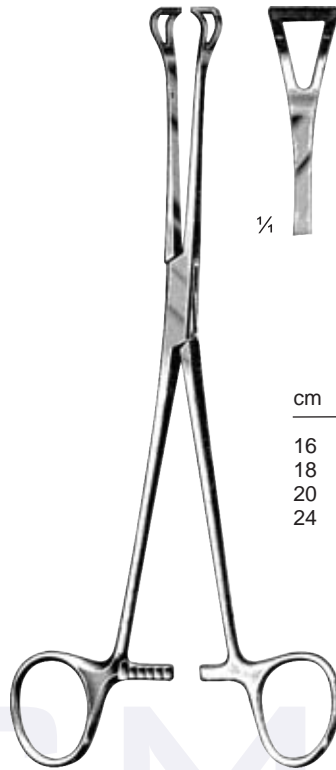

**Babcock**

cm	in.	
16	6 1/4	DC15-077-16
18	7	DC15-077-18
20	8	DC15-077-20
24	9 1/2	DC15-077-24



**Babcock**  
DC15-079-16 = 16 cm/6 1/4"  
DC15-079-20 = 20 cm/8"

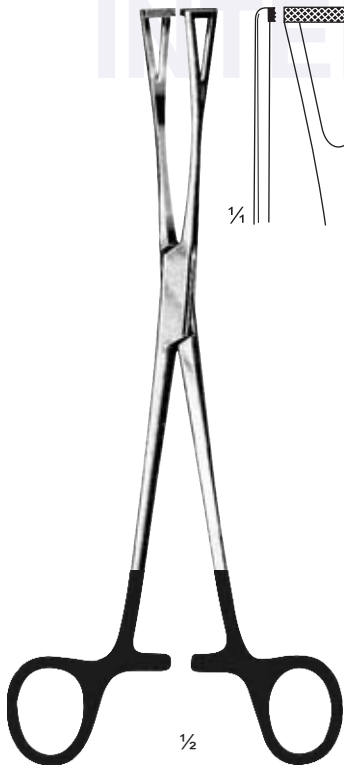

**Duval**  
DC15-081-20  
20 cm /8"

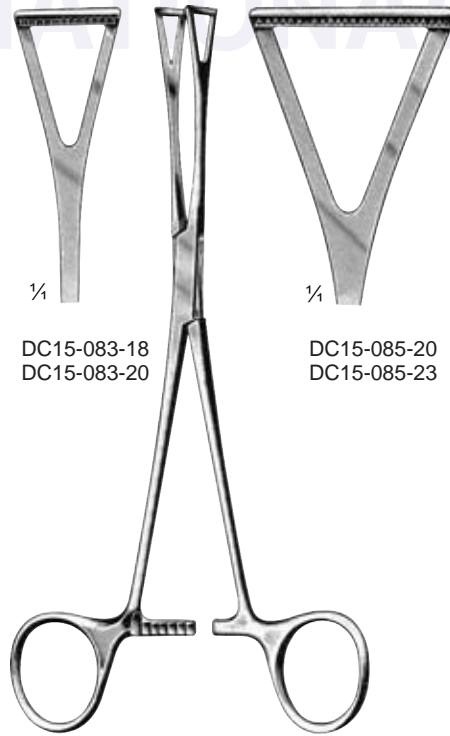

Duval			Duval		
cm	in.		cm	in.	
18	7	DC15-083-18	20	8	DC15-085-20
20	8	DC15-083-20	23	9	DC15-085-23

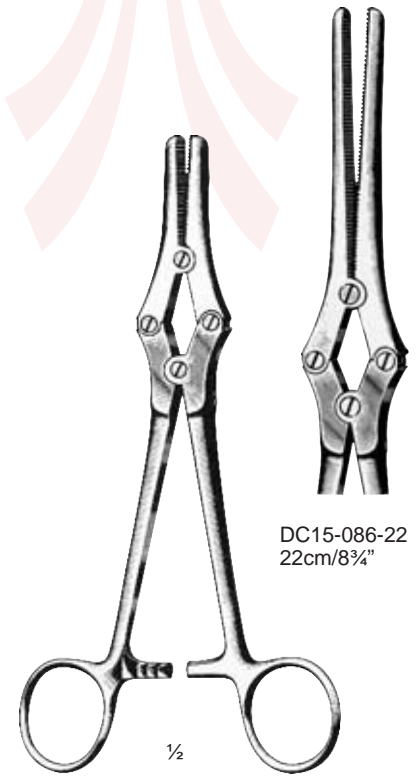

**Zweifel**  
DC15-086-17  
17cm/6 3/4"  
Appendectomy Clamps



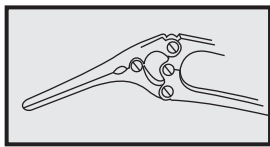

Tissue Seizing Forceps, Intestinal Tissue Forceps  
Organ Holding Forceps



**Williams**  
DC15-087-16  
16 cm / 6 1/4"



**Thoms-Allis**  
DC15-089-20  
20 cm / 8"



**Lockwood**  
DC15-091-20  
20 cm / 8"

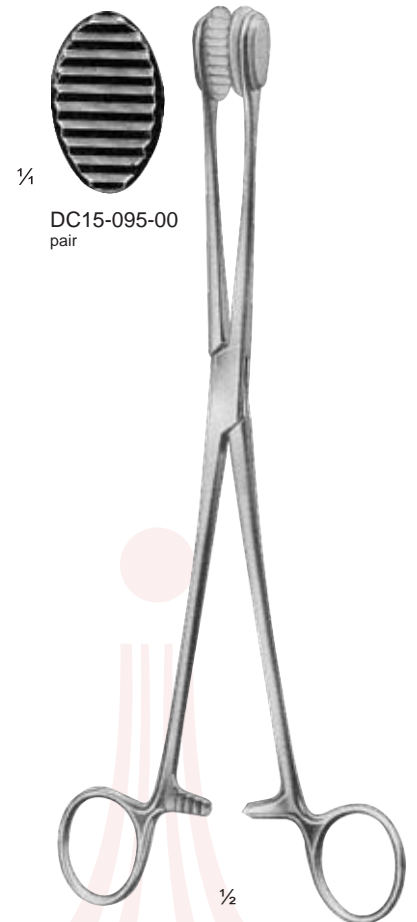

**Child**  
DC15-093-24  
24 cm / 9 1/2"

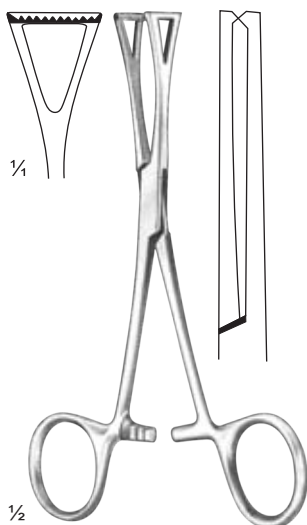

**Collin**  
DC15-097-14  
14cm/5 1/2"

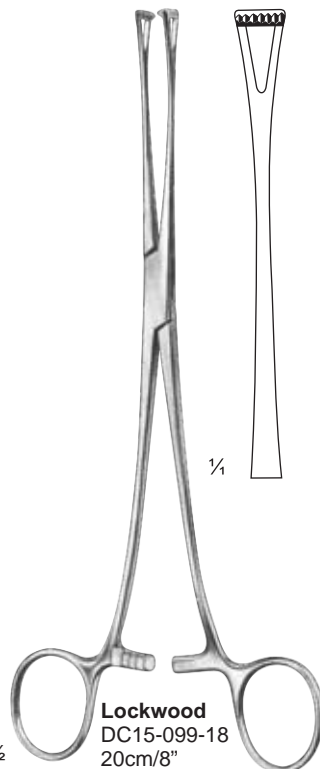

**Lockwood**  
DC15-099-18  
20cm/8"

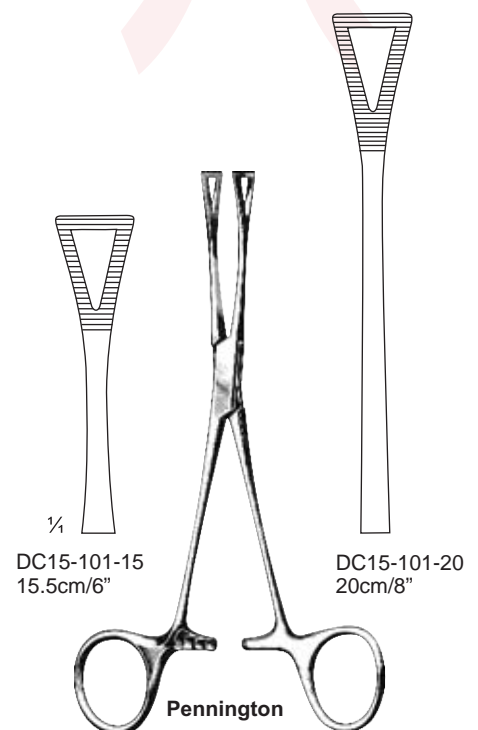

**Pennington**  
DC15-101-15  
15.5cm/6"

DC15-101-20  
20cm/8"

Atrauma Sigmoid Anastomosis Forceps  
Atrauma Intestinal and Stomach Clamp Forceps

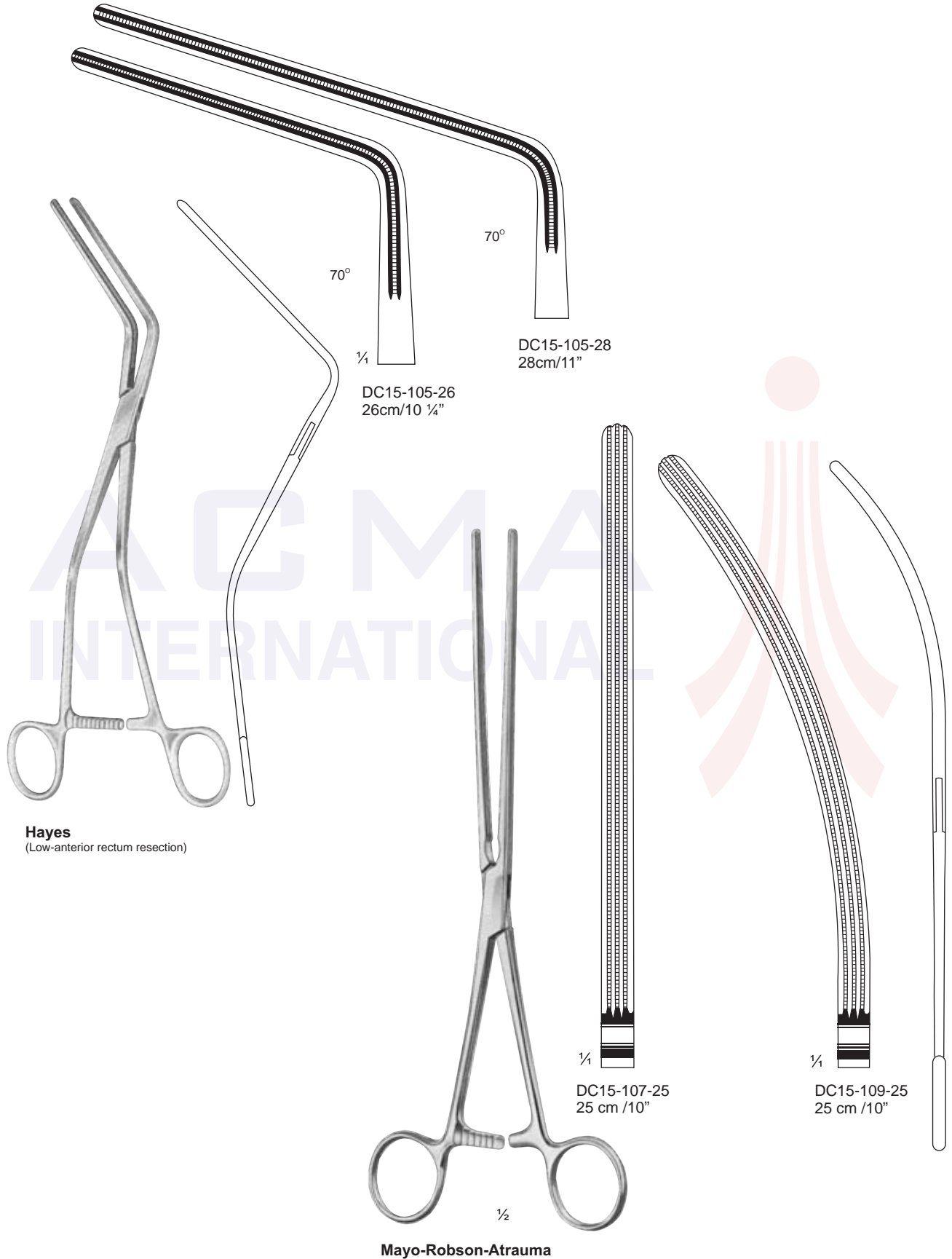
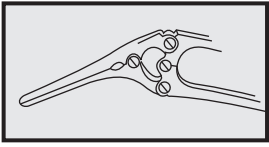

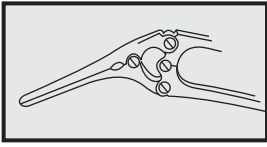

Atrauma Intestinal and Stomach Clamp Forceps



**Doyen-Atrauma**  
DC15-111-18 - DC15-111-23



1/4  
DC15-111-16  
16 cm / 6 1/2"



1/4  
DC15-111-18  
18 cm / 7"

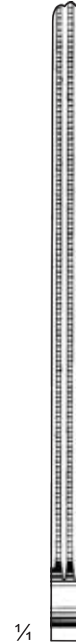

1/4  
DC15-111-21  
21 cm / 8 1/2"

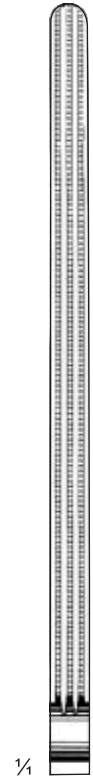

1/4  
DC15-111-23  
23 cm / 9"



**Doyen-Atrauma**  
DC15-113-18 - DC15-113-23

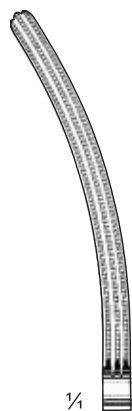

1/4  
DC15-113-16  
16 cm / 6 1/2"

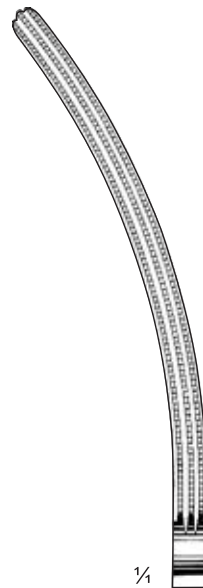

1/4  
DC15-113-18  
18 cm / 7"

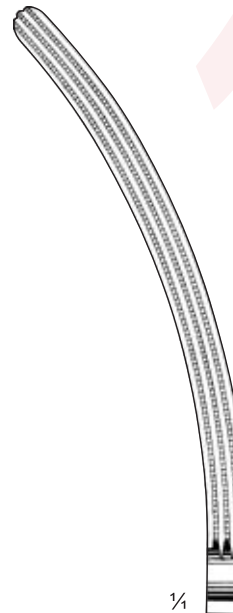

1/4  
DC15-113-21  
21 cm / 8 1/2"

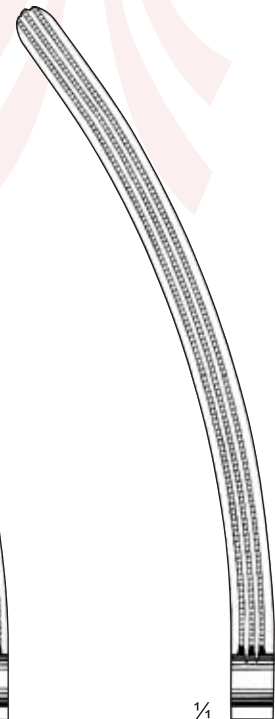

1/4  
DC15-113-23  
23 cm / 9"

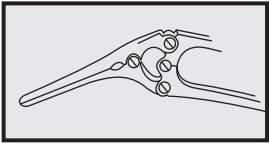

Atrauma Intestinal and Stomach Clamp Forceps



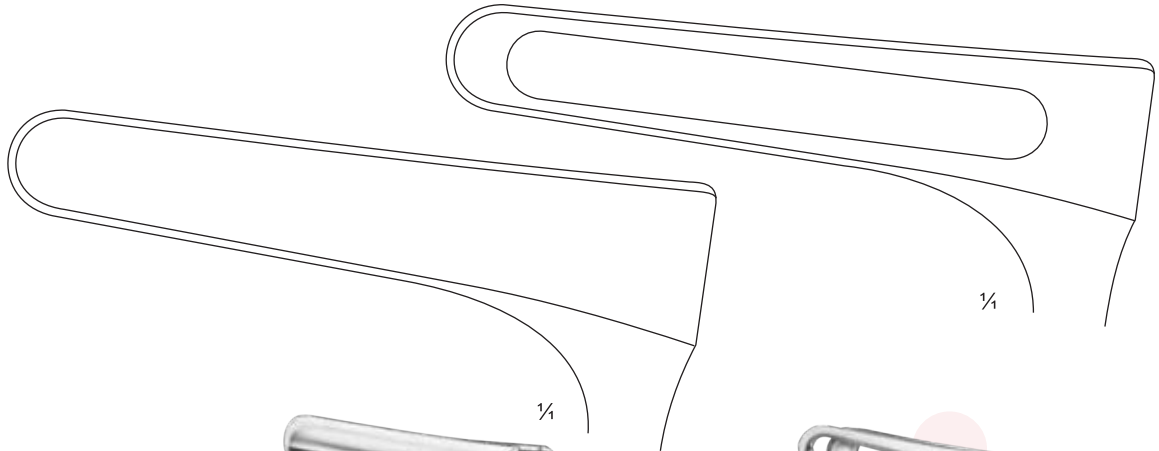
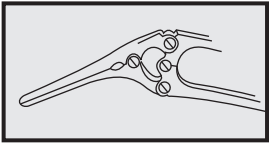

**Czerny**  
DC15-119-21  
22 cm / 8 3/4



**Sims**  
DC15-121-15  
15 cm / 6"



**Sims**  
DC15-123-15  
15 cm / 6"

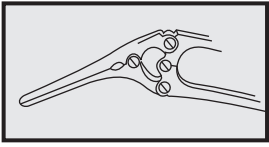

Rectal Specula

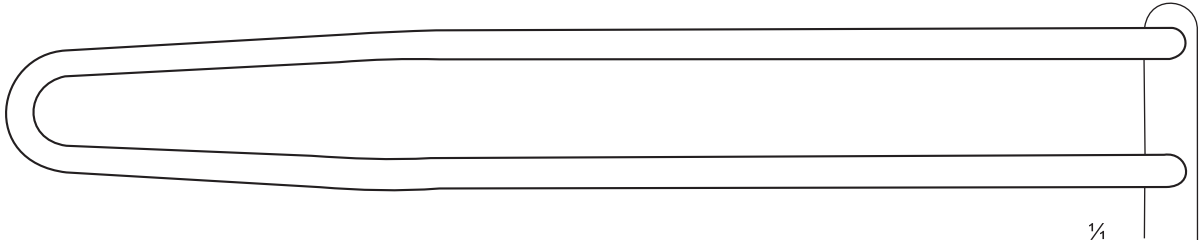

DC15-125-15  
Length of Blades 150 mm

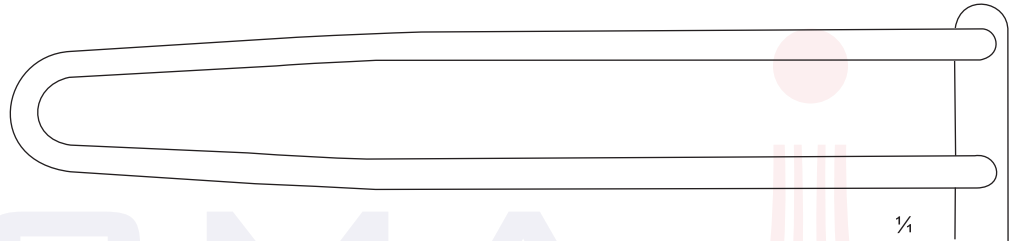

DC15-125-12  
Length of Blades 125 mm

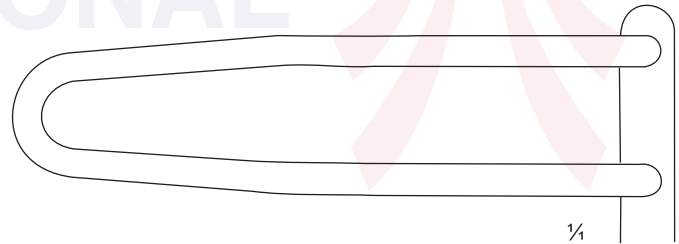

DC15-125-08  
Length of Blades 80 mm



**Schulze-Bergmann**  
DC15-125-06 - DC15-125-15

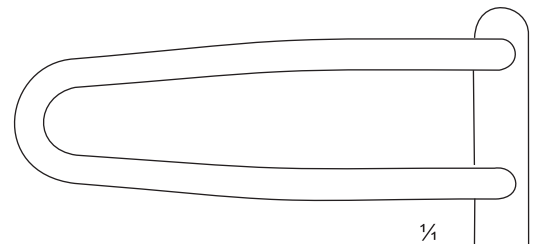

DC15-125-06  
Length of Blades 60 mm

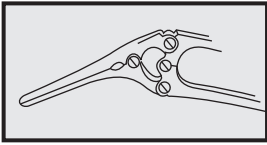

Rectal Specula, Anal Retractors

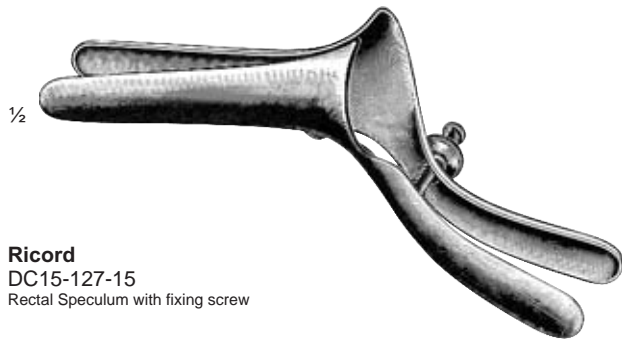

**Ricord**  
DC15-127-15  
Rectal Speculum with fixing screw

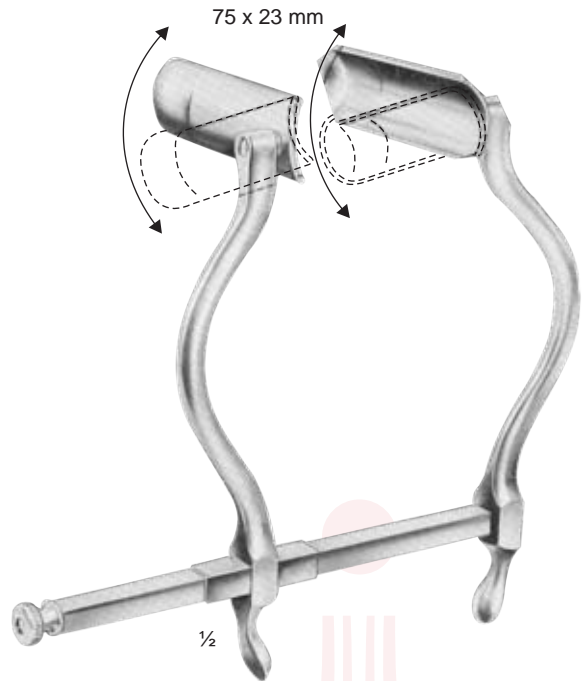

**Smith-Buie**  
DC15-129-15  
15 cm / 6"  
Anal Retractor,  
with swivel blades



90 x 15 mm

**Mathieu**  
DC15-131-19  
19.5 cm / 7 3/4"  
Rectal Specula, three-Bladed,  
with fixing screw

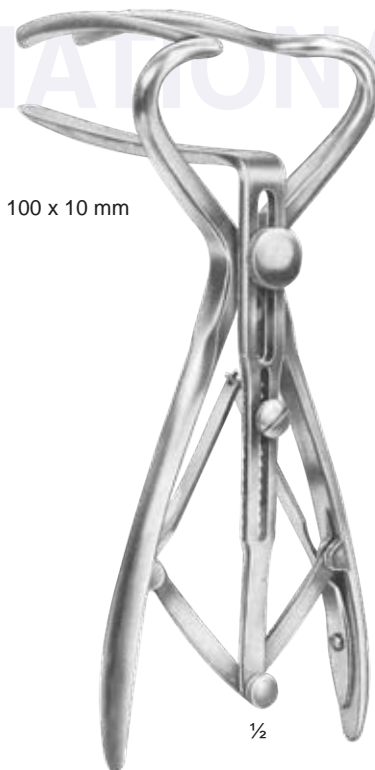

100 x 10 mm

**Cook**  
DC15-133-19  
19.0 cm / 7 1/2"  
Rectal Specula, three-Bladed,  
with fixing screw



70 x 22 mm

**Barr**  
DC15-135-17  
17 cm / 6 3/4"  
Rectal Speculum  
with Loktite ratchet

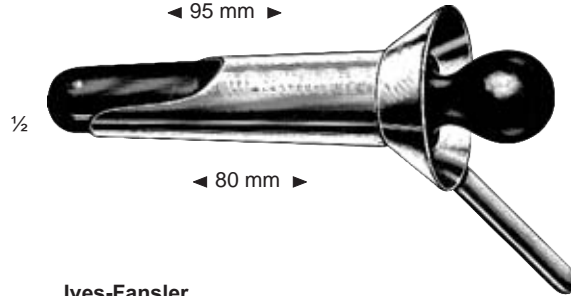
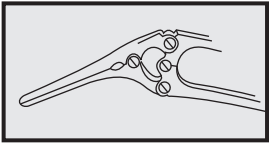

**Ives-Fansler**  
DC15-137-15  
22 mm  $\varnothing$   
Anoscope, with vulcanite obturator



**Bensaude**  
DC15-139-01 = 19 mm  $\varnothing$  x 70 mm  
DC15-139-02 = 22 mm  $\varnothing$  x 70 mm  
Anoscopes, with obturator,  
revolving tube with obturator



**Mod. Martin**  
DC15-141-01 = 22 mm  $\varnothing$  x 50 mm  
DC15-141-02 = 22 mm  $\varnothing$  x 75 mm  
DC15-141-03 = 22 mm  $\varnothing$  x 100 mm

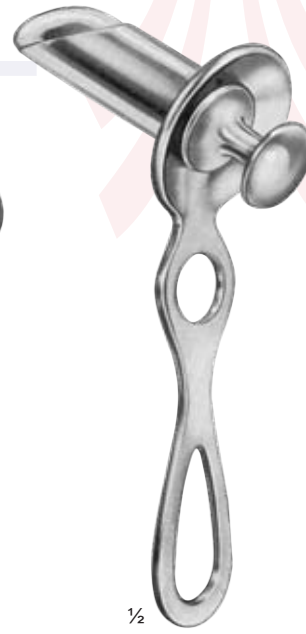

**Hirschmann**  
DC15-143-01 = Fig. 1 16 mm  $\varnothing$  x 65 mm  
DC15-143-02 = Fig. 2 19 mm  $\varnothing$  x 65 mm  
DC15-143-03 = Fig. 3 22 mm  $\varnothing$  x 65 mm  
DC15-143-04 = Fig. 4 22 mm  $\varnothing$  x 125 mm  
Anoscopes, with obturator



Anoscopes, Rectal Biopsy Specimen Forceps

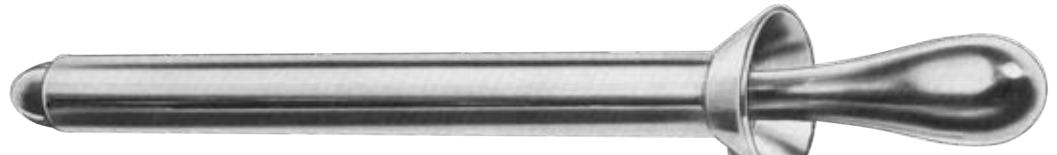
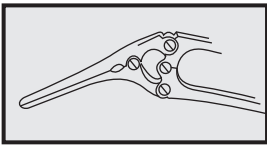

**Newman**  
 DC15-145-01 = 16 mm ø x 63 mm  
 DC15-145-02 = 19 mm ø x 63 mm  
 DC15-145-03 = 23 mm ø x 63 mm  
 Proctoscopes, with obturator

**Kelly**  
 DC15-147-01 = 22 mm ø x 050 mm  
 DC15-147-02 = 22 mm ø x 100 mm  
 DC15-147-03 = 22 mm ø x 140 mm  
 DC15-147-04 = 22 mm ø x 200 mm  
 Proctoscopes, with obturator



**Kelly**  
 DC15-149-01 = 21 mm ø x 50 mm  
 DC15-149-02 = 27 mm ø x 50 mm  
 Sphincteroscopes, with obturator

ACMA INTERNATIONAL

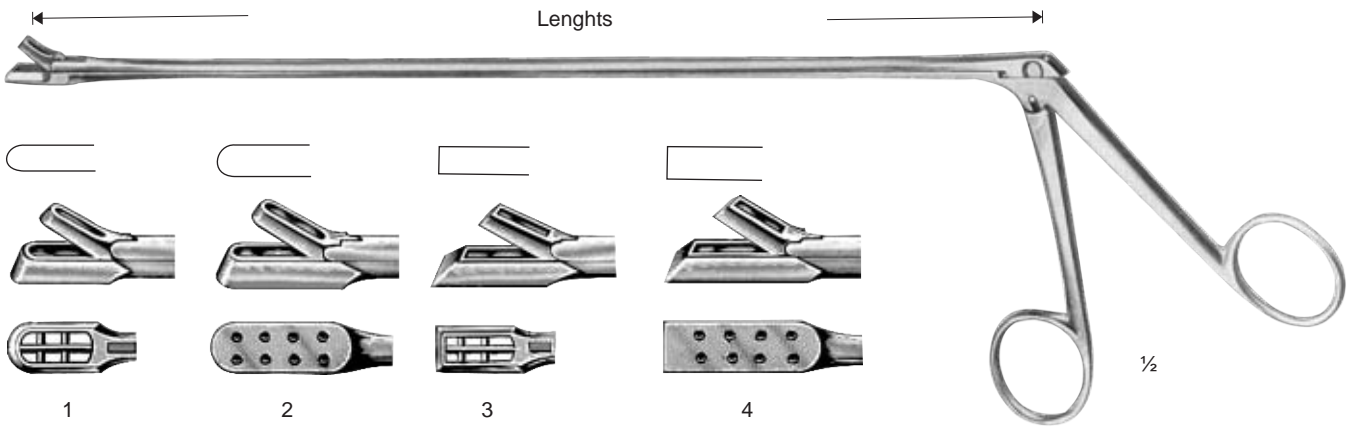

**Yeoman**

cm	in.	Fig. 1	2	3	4
28	11	DC15-151-28	DC15-153-28	DC15-155-28	DC15-157-28
35	13 ¾	DC15-151-35	DC15-153-35	DC15-155-35	DC15-157-35
42	16 ½	DC15-151-42	DC15-153-42	DC15-155-42	DC15-157-42

Angiotribes, Hemostatic Forceps, Haemorrhoidal (Pile) Forceps  
Pinzas-Clamps Hemorroidals

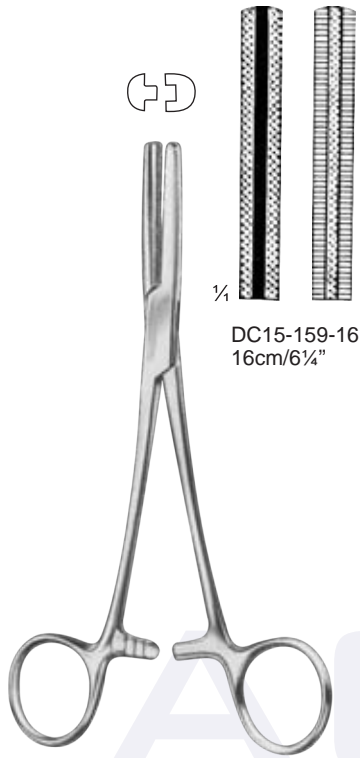
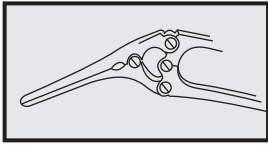

DC15-159-16  
16cm/6¼"

Fergusson

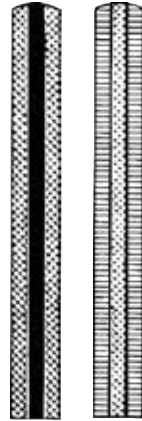

DC15-159-20  
20cm/8"

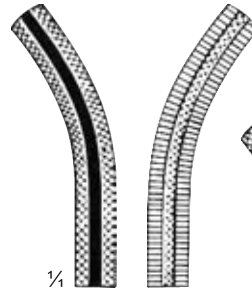

DC15-161-16  
16cm/6¼"

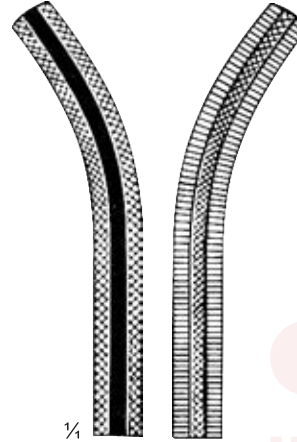

DC15-161-20  
20cm/8"

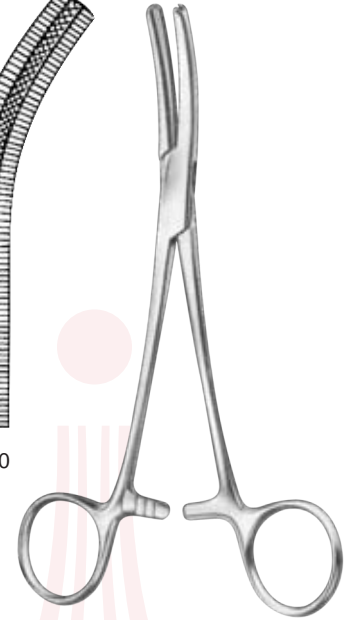

Fergusson

Scalp Flap Forceps

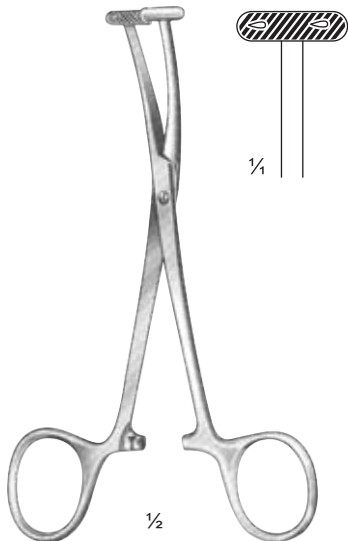

DeMartel  
DC15-163-14  
14cm/5½"



DeMartel (Willett)  
DC15-165-18  
18cm/7"

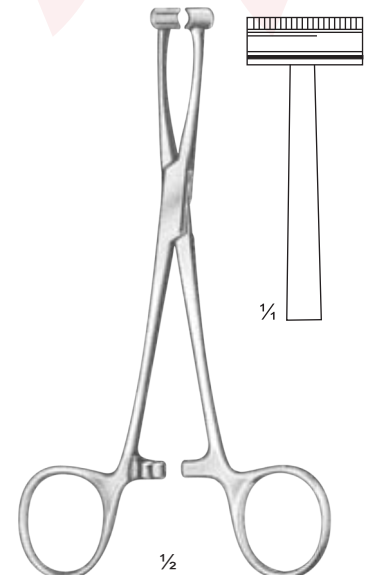

Pratt  
DC15-167-15  
15cm/6"

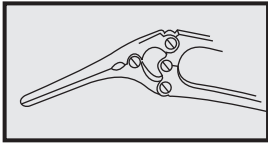

Angiotribe, Hemostatic Forceps, Haemorrhoidal (Pile) Forceps



**Heywood-Smith**  
DC15-169-20  
20 cm / 8"

**Heywood-Smith**  
DC15-171-21  
21 cm / 8 1/4"

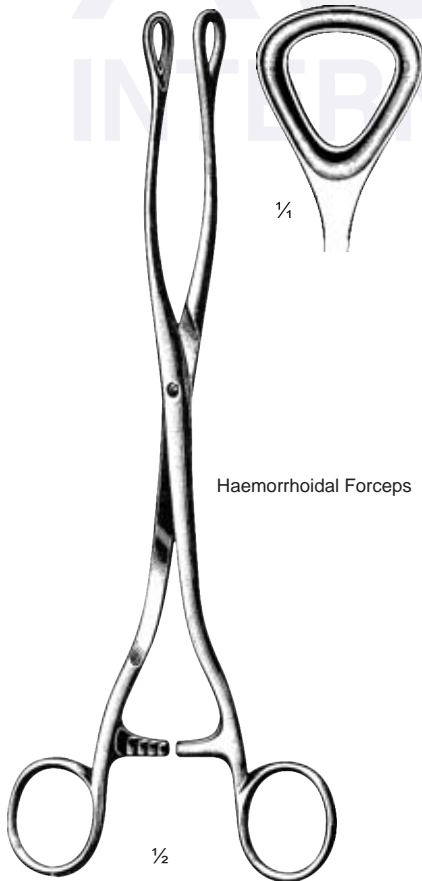

Haemorrhoidal Forceps

**Luer**  
DC15-173-24  
24.5cm/9 3/4"



**Guy**  
DC15-175-19  
19cm/7 1/2"

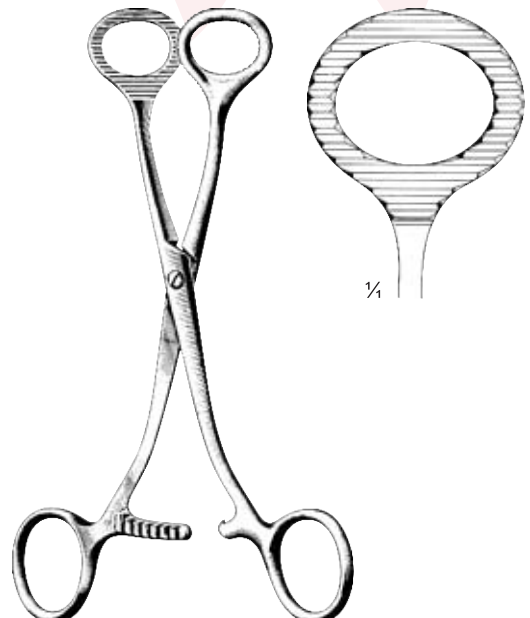

**Collin**  
DC15-177-17 = 17cm/6 3/4"  
DC15-177-19 = 19cm/7 1/2"

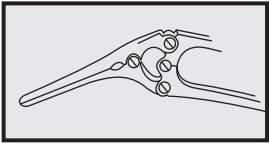

Stomach, Intestine, Rectum

Haemorrhoidal Ligators

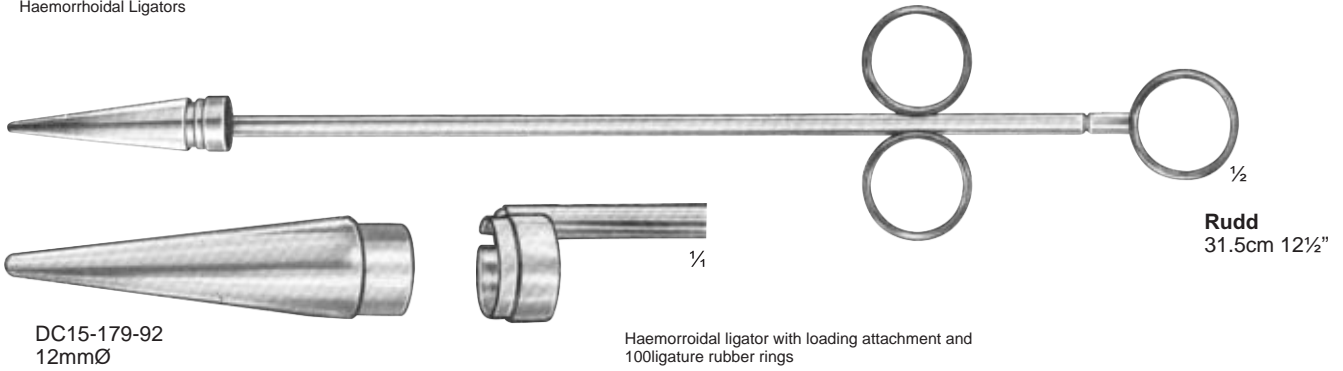

DC15-179-92  
12mmØ

Haemorrhoidal ligator with loading attachment and 100ligature rubber rings

**Rudd**  
31.5cm 12½"

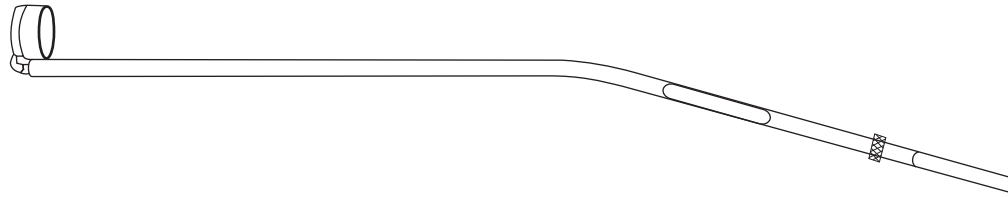

DC15-180-12  
Straight

DC15-181-12  
curved



¼  
Ligature rubber rings  
in package of 100pieces  
DC15-183-99



Haemorrhoidal Forceps

**McGivney**  
DC15-185-19  
19cm/7½"

DC15-187-88 = 8mmØ  
DC15-187-90 = 10mmØ  
Loading Cones

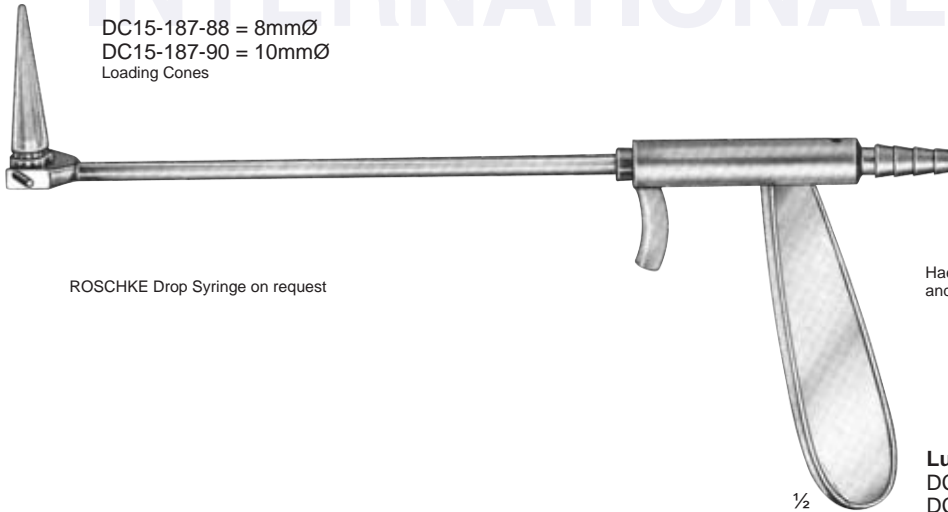

Haemorrhoidal Suction Ligator with loading attachment and 100 ligature rubber rings

**Lurz**  
DC15-187-08 = 8mmØ  
DC15-187-10 = 10mmØ

ROSCHKE Drop Syringe on request

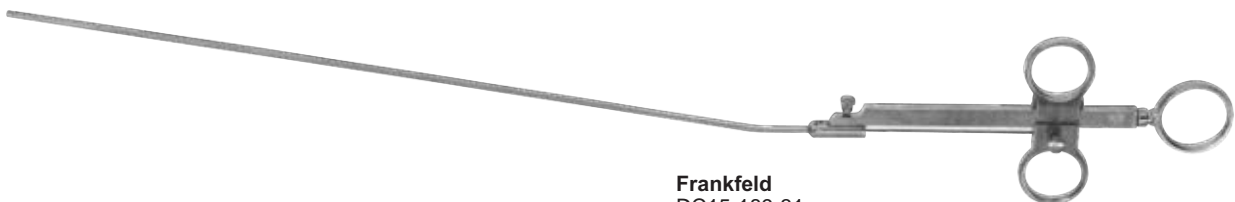

**Frankfeld**  
DC15-189-31  
working length:30.5cm/12"